



# Recommended Practices for 3D Associative Text

- Release 4 -

January 13<sup>th</sup>, 2000

## **Contacts:**

Rogerio Barra  
ATI/PDES, Inc.  
5300 International Blvd.  
North Charleston, SC 29418 USA  
[barra@aticorp.org](mailto:barra@aticorp.org)

Markus Hauser  
ProSTEP GmbH  
Julius-Reiber-Str. 15  
64293 Darmstadt  
[hauser@prostep.de](mailto:hauser@prostep.de)

# **Table of Contents**

<b>1</b>	<b>Introduction .....</b>	<b>1</b>
<b>2</b>	<b>Scope .....</b>	<b>1</b>
<b>3</b>	<b>Fundamental concepts .....</b>	<b>1</b>
3.1	SHAPE_REPRESENTATION VERSUS DRAUGHTING_MODEL .....	1
3.2	DEFINING TEXT AND PLACING IT IN MODEL SPACE .....	2
3.3	STYLING ANNOTATION .....	3
3.4	ASSOCIATIVITY BETWEEN SEPARATE ELEMENTS OF ANNOTATION .....	4
3.5	ASSOCIATIVITY BETWEEN ANNOTATION AND GEOMETRIC MODEL ELEMENTS .....	4
3.6	LOGICAL COMBINATION OF ANNOTATION ELEMENTS .....	5
3.7	VISUAL DEPICTION OF ASSOCIATIVITY WITH LEADER CURVE .....	5
3.8	COMBINATIONS OF BUILDING BLOCKS DEFINED FOR THIS CAPABILITY .....	6
3.8.1	<i>Non-styled vs. styled text</i> .....	6
3.8.2	<i>Usage of callouts</i> .....	6
<b>4</b>	<b>Part 21 file example .....</b>	<b>7</b>
4.1	CONFORMING TO AP214 .....	7
4.2	CONFORMING TO AP203 WITH A MODULAR EXTENSION .....	13
<b>5</b>	<b>Known issues .....</b>	<b>20</b>
5.1	RESTRICTIVENESS OF SHAPE_ASPECT_ASSOCIATIVITY .....	20
5.2	AP 214 GLOBAL RULES .....	20
5.3	ASSOCIATED_DRAUGHTING_CALLOUT APPLICATION OBJECT IN AP214 ARM .....	20
5.4	AP 203 GLOBAL RULES .....	20
<b>6</b>	<b>Availability of implementation schemas .....</b>	<b>21</b>
6.1	AP214 .....	21
6.2	AP203 WITH MODULAR EXTENSIONS .....	21
<b>7</b>	<b>Summary of changes to Document .....</b>	<b>21</b>
7.1	CURRENT RELEASE .....	21
7.1.1	<i>Contacts</i> .....	21
7.1.2	<i>Section 3.4 Associativity between separate elements of annotation</i> .....	21
7.1.3	<i>Section 3.8.3 Usage of annotation_occurrence_associativity deleted</i> .....	21
7.1.4	<i>#2000 in Part 21 file example deleted</i> .....	21
7.1.5	<i>Modification in Figure 11: Instance Diagram 2</i> .....	22
7.1.6	<i>Known Issue: Section 5.2 Restrictiveness of annotation_occurrence_associativity deleted</i> .....	22

## **List of Figures**

FIGURE 1:	MAPPING OF ANNOTATION AND SHAPE INTO THE DRAUGHTING MODEL .....	2
FIGURE 2:	ANNOTATION TEXT AND GEOMETRY COMBINED IN A HYBRID SHAPE REPRESENTATION .....	2
FIGURE 3:	FUNCTIONALITY FOR ADDITIONAL REQUIREMENTS RELATED TO TEXT_LITERALS .....	3
FIGURE 4:	STYLING ANNOTATION TEXT .....	4
FIGURE 5:	ASSOCIATION BETWEEN LEADER CURVE AND ANNOTATION TEXT .....	4
FIGURE 6:	ASSOCIATIVITY BETWEEN A PORTION OF THE GEOMETRY (EDGE_CURVE) AND ANNOTATION (THE DRAUGHTING_CALLOUT) .....	5
FIGURE 7:	LOGICAL COMBINATION OF ANNOTATION ELEMENTS .....	5
FIGURE 8:	REPRESENTATION OF LEADER CURVE .....	6

FIGURE 9 : EXAMPLE .....	7
FIGURE 10 : INSTANCE DIAGRAM 1 .....	19
FIGURE 11 : INSTANCE DIAGRAM 2 .....	20

# 1 Introduction

This document describes the recommended practices for implementing 3D associative text. If questions arise during your review of this document, please contact any of the persons listed on the cover page of this document. This document reflects the latest agreements from the AP214 DIS ballot workshop in New Orleans.

# 2 Scope

The information presented in this document covers how a STEP implementation would support:

- the definition of text and its placement within model space;
- the definition of curve and symbol annotation for leader lines;
- limited styling of text, curve and symbol annotation;
- placement of styled annotation within the same coordinate space containing a three-dimensional geometric model;
- associativity between separate annotation elements;
- associativity between annotation and geometric model elements.

# 3 Fundamental concepts

Particular concepts of interest within the scope of this recommendation are described within the following paragraphs.

## 3.1 Shape\_representation versus Draughting\_model

The concept of a **shape\_representation** is widely known by STEP developers and implementers. Many STEP implementations already exist that support subtypes of **shape\_representation** that contain locally defined constraints defining the type of geometry the **shape\_representation** can represent (e.g., **advanced\_brep\_shape\_representation**, **manifold\_surface\_shape\_representation**).

AP202 and AP214 introduce another representation concept, known as a **draughting\_model**. First of all, the name of this entity is a misnomer, since it can be used to represent representations that are not draughting-related. Conceptually, a **draughting\_model** is a **representation** that may contain geometry and styled annotation within the same coordinate space.

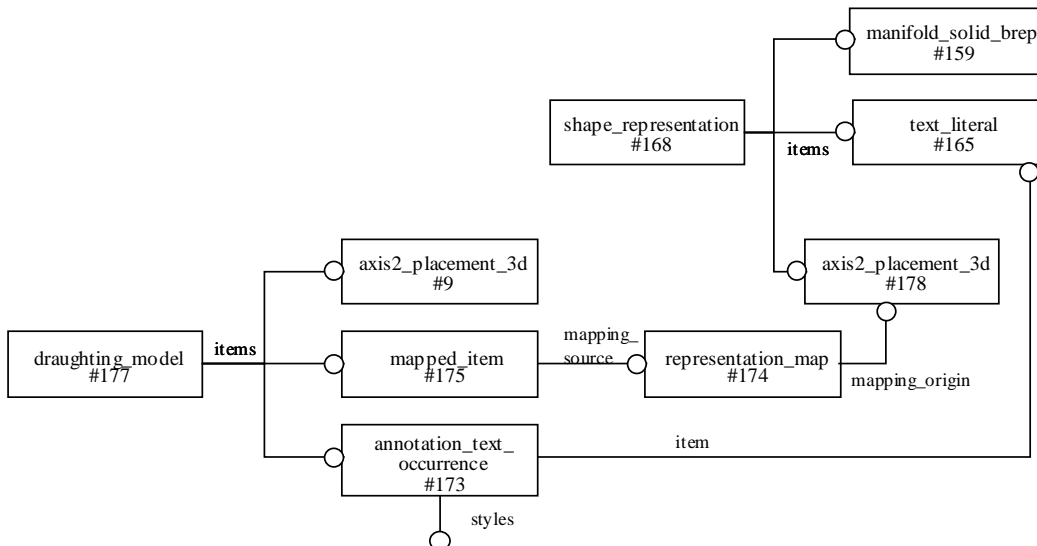

FIGURE 1: MAPPING OF ANNOTATION AND SHAPE INTO THE DRAUGHTING MODEL

This is achieved by ensuring that all items of a **draughting\_model** are **mapped\_item** entity data types, **styled\_item** entity data types, or an **axis2\_placement**. A **mapped\_item** would represent the mapping of a **shape\_representation** that defines the shape of a product that is to be presented.

In the case of styling text - and thus using draughting model in addition to the annotated shape\_representation - the **text\_literal** is founded twice. It is then founded in the **shape\_representation** it annotates and via **annotation\_text\_occurrence** in the **draughting\_model**. To ensure the consistency of the placement of the text it is necessary that the coordinate-systems of the **draughting\_model** and the **shape\_representation** be identical. Thus, it is required that the transformation between the annotated **shape\_representation** and the **draughting\_model** established via **mapped\_item** and **representation\_map** be the identity-transformation.

The **draughting\_model** may also contain **annotation\_occurrence** entity data types (NOTE: an **annotation\_occurrence** is a subtype of a **styled\_item**). These specify annotation that is placed in the same coordinate space as the **shape\_representation**.

### 3.2 Defining text and placing it in model space

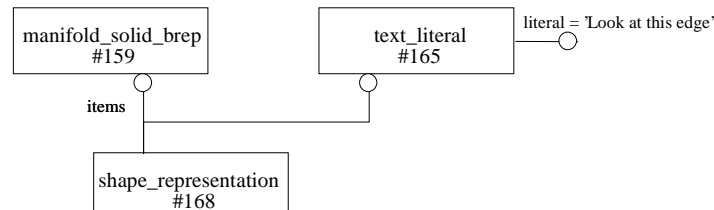

FIGURE 2: ANNOTATION TEXT AND GEOMETRY COMBINED IN A HYBRID SHAPE REPRESENTATION

Text is defined by a **text\_literal**. Its *.literal* attribute defines the text string and its *.font* attribute references the text font used to present the text string. Since the **text\_literal** is a subtype of **geometric\_representation\_item**, it can be listed as an item of a generic **shape\_representation** (i.e., not within one of its already-defined and well-known subtypes). The intent of placing the **text\_literal** in a **shape\_representation** is to

- allow for the exchange of non-styled text;
- the ability to relate this non-styled text to an **annotation\_text\_occurrence** located within a **draughting\_model**.

To specify the physical space that the text occupies the **text\_literal\_with\_extent** subtype of **text\_literal** may be used. It includes the *.extent* attribute that captures the extent by referencing a **planar\_extent** entity data type. This extent is defined by:

- width - the distance of the left-most point of the left-most character to the right-most point of the right-most character measured parallel to the text baseline

and

- height - the distance of the lowest point of the lowest reaching character to the highest point of the highest reaching character measured perpendicular to the text baseline.

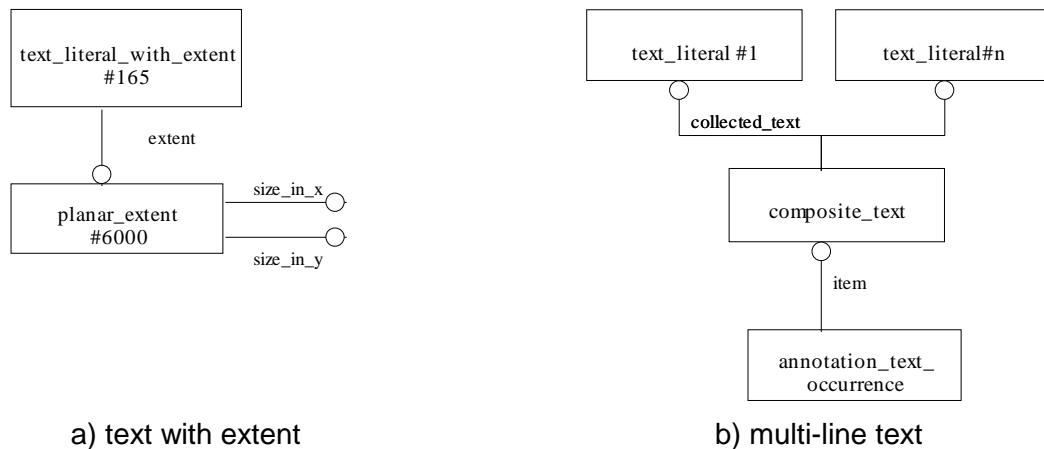

FIGURE 3: FUNCTIONALITY FOR ADDITIONAL REQUIREMENTS RELATED TO TEXT\_LITERALS

Support for multi-lined text is also within the scope of this document. This can be achieved by using the **composite\_text** entity data type (or its **composite\_text\_with\_extent** subtype), which is no more than an entity that defines a set of **text\_literal** entity data types.

### 3.3 Styling annotation

A subtype of **annotation\_occurrence** defines styled annotations. Within the scope of this effort all **annotation\_occurrence** entity data types will be instantiated as complex instances, since **annotation\_occurrence** entity data types are subtypes of both a **draughting\_annotation\_occurrence** and a **styled\_item**.

The subtypes of **annotation\_occurrence** that are within the scope of this effort are **annotation\_text\_occurrence**, **annotation\_curve\_occurrence**, and **annotation\_symbol\_occurrence**. Each has an *.item* attribute that references the item that is to be styled. In the case of the **annotation\_text\_occurrence**, the item is a **text\_literal**; in the case of the **annotation\_curve\_occurrence**, the item is a **trimmed\_curve**; and in the case of the **annotation\_symbol\_occurrence**, the item is a **defined\_symbol**.

Additionally, each **annotation\_occurrence** has a *.styles* attribute that is used to assign that occurrence's particular style by referencing the **presentation\_style\_assignment** entity data type. The **presentation\_style\_assignment** lists the required style for that instance of an **annotation\_occurrence** (i.e., **text\_style** for **annotation\_text\_occurrence**, **curve\_style** for **annotation\_curve\_occurrence**, and **symbol\_style** for **annotation\_symbol\_occurrence**).

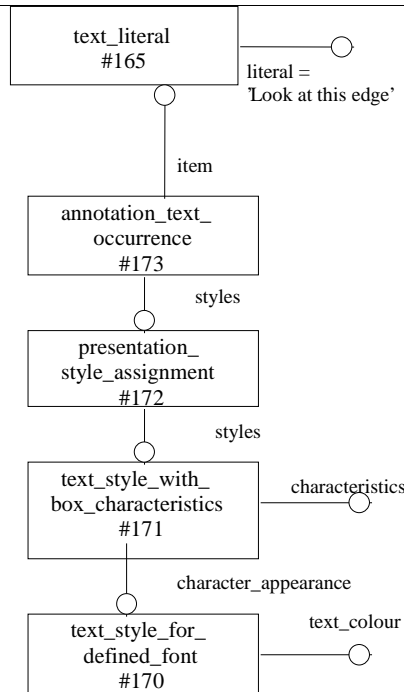

FIGURE 4: STYLING ANNOTATION TEXT

### 3.4 Associativity between separate elements of annotation

The method of explicitly relating separate annotation elements can be achieved using the **annotation\_occurrence\_associativity** entity data type. Notice that the `related_annotation_occurrence` is constrained to `leader_curve`, `projection_curve` or `annotation_fill_area_occurrence`.

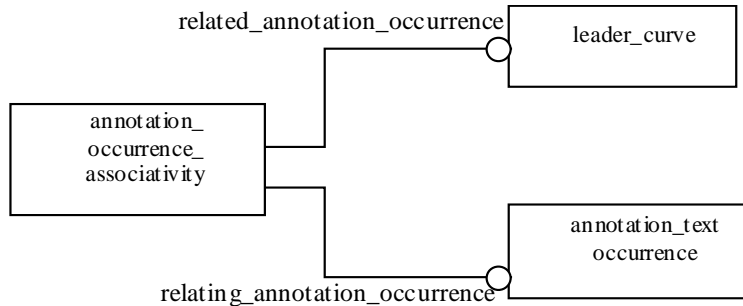

FIGURE 5: ASSOCIATION BETWEEN LEADER CURVE AND ANNOTATION TEXT

### 3.5 Associativity between annotation and geometric model elements

A method of associating annotation with elements of a geometric model can be achieved using the **shape\_aspect\_associativity** entity data type. The first **shape\_aspect** captures the portions of a geometric model that are to be associated with annotation. The second **shape\_aspect** captures the annotation elements that are to be associated with elements of a geometric model.

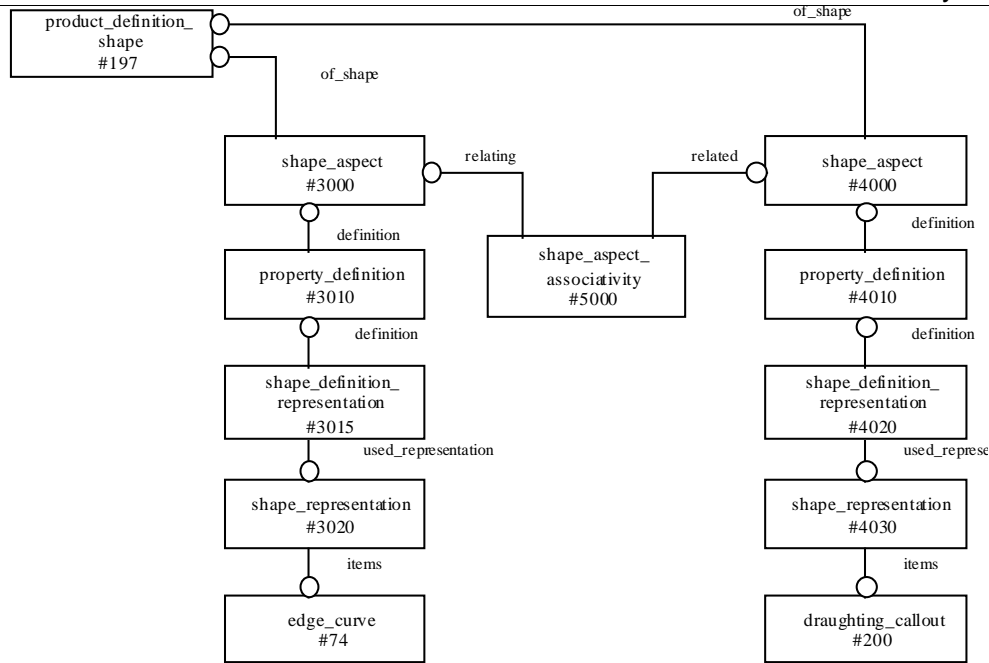

FIGURE 6: ASSOCIATIVITY BETWEEN A PORTION OF THE GEOMETRY (EDGE\_CURVE) AND ANNOTATION (THE DRAUGHTING\_CALLOUT)

### 3.6 Logical combination of annotation elements

Information depicted via annotation elements is typically grouped in callouts. In the scope of this effort two types of callouts are used: **draughting\_callout** and **leader\_directed\_callout**. A **draughting\_callout** is a collection of annotation element. A **leader\_directed\_callout** is a subtype of a **draughting\_callout** that includes a leader line to direct the eye of the reader to a place of interest. In the context of associative text a **leader\_directed\_callout** shall be instantiated when a leader line, that visually depicts the association of text with some elements of the geometric model, is present. There are scenarios in which it is not desired to exchange such leader curves. In these cases a **draughting\_callout** shall be instantiated.

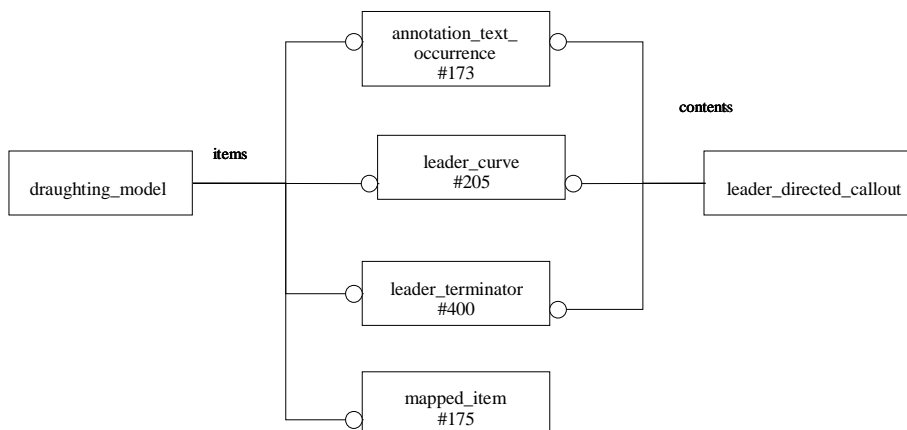

FIGURE 7: LOGICAL COMBINATION OF ANNOTATION ELEMENTS

### 3.7 Visual depiction of associativity with leader curve

The associativity between an annotation text and elements of the shape representation can be visually depicted via a **leader\_curve**. A **leader\_curve** is a complex instance with **annotation\_curve\_occurrence**, **annotation\_occurrence**, **draughting\_annotation\_occurrence**,



**leader\_curve**, **representation\_item**, **geometric\_representation\_item** and **styled\_item**. The **styled\_item.item** points to the underlying geometry of the **leader\_curve**. At the target end a leader line is terminated by a **leader\_terminator** symbol. **Leader\_terminator** has again a complex instantiation corresponding to the instantiation of **leader\_curve**. The name attribute inherited from **styled\_item** points to a **defined\_symbol**. In the scope of this effort **defined\_symbol** represents an implicit definition of a symbol. **Defined\_symbol** points to a **pre\_defined\_terminator\_symbol** that gives a description of the symbol and a **symbol\_target** that represents location and orientation of the symbol instance. **Pre\_defined\_terminator\_symbol** can be instantiated with the names 'blanked arrow', 'blanked box', 'blanked dot', 'dimension origin', 'filled arrow', 'filled box', 'filled dot', 'integral symbol', 'open arrow', 'slash' or 'unfilled arrow'.

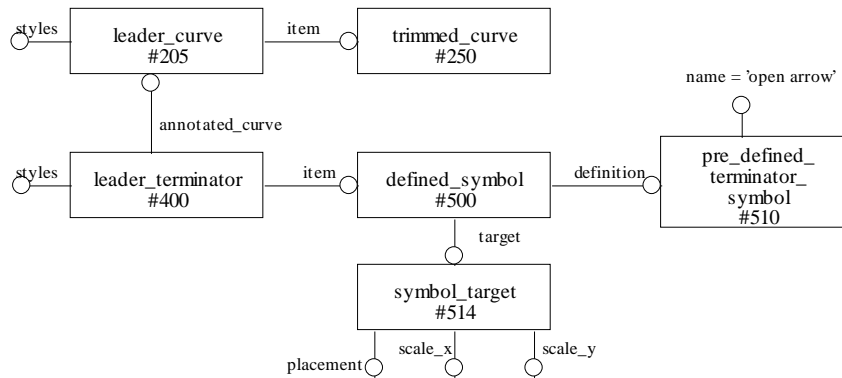

FIGURE 8: REPRESENTATION OF LEADER CURVE

### 3.8 Combinations of building blocks defined for this capability

The capability described herein supports:

1. text in 3D model
2. styled text in 3D model
3. text associated to elements of the 3D model
4. visual depiction of the association of text to elements of the model.

The approach is designed to be modular, i.e. depending on the scope of the intended data exchange the capability can be supported by a combination of the corresponding functional building blocks.

To facilitate the interpretation of associative text part21 files the following sections give some guidelines on traversing the files.

#### 3.8.1 Non-styled vs. styled text

**Text literals** not referenced by an **annotation\_text\_occurrence** are non-styled text elements. These **text literals** occur as items of the annotated **shape\_representation**. Styled text is as well part of the items list of the annotated **shape\_representation** but additionally has an instance of **annotation\_text\_occurrence** pointing to it. The instances of **annotation\_text\_occurrence** are founded in the **draughting\_model**.

#### 3.8.2 Usage of callouts

If associativity between annotation text elements and portions of shape shall be represented, the associativity is implemented via **shape\_aspect\_associativity** that associates the respective portion of shape with a **draughting\_callout**. Thus if associativity is desired, a callout has to be used. If the

associativity does involve a leader curve, then **leader\_directed\_callout** shall be instantiated. In scenarios in which the exchange of the leader lines is not desired the supertype **draughting\_callout** shall be instantiated.

If the styled text is used to annotate a shape without associativity, it is not necessary to instantiate **draughting\_callout**.

## 4 Part 21 file example

The following is an example of a resulting Part 21 file that supports 3D associated annotation text. The picture that it represents is the following:

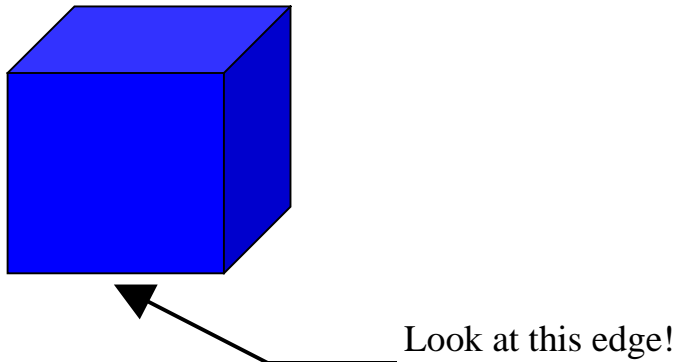

FIGURE 9 : EXAMPLE

### 4.1 Conforming to AP214

```
ISO-10303-21;
HEADER;
FILE_DESCRIPTION(('associative text example',''),'2;1');
FILE_NAME('assoctext214.stp',
          '1998-11-02 T012351',
          (''),
          ('','','',''),
          '',
          '',
          '');
FILE_SCHEMA(('AUTOMOTIVE_DESIGN {1 2 10303 214 0 1 1 1}'));
ENDSEC;
DATA;
/* Instances #1-#159 define the cube depicted above. */
#1=DIMENSIONAL_EXPONENTS(1.0,0.0,0.0,0.0,0.0,0.0,0.0);
#2=DIMENSIONAL_EXPONENTS(0.0,0.0,0.0,0.0,0.0,0.0,0.0);
#3=(NAMED_UNIT(*)SI_UNIT($,.STERADIAN.)SOLID_ANGLE_UNIT());
#4=(LENGTH_UNIT()NAMED_UNIT(*)SI_UNIT(.MILLI.,.METRE.));
#5=(NAMED_UNIT(*)PLANE_ANGLE_UNIT()SI_UNIT($,.RADIAN.));
#6=CARTESIAN_POINT('#6',(0.0,0.0,0.0));
#7=DIRECTION('#7',(1.0,0.0,0.0));
#8=DIRECTION('#8',(0.0,0.0,1.0));
#9=AXIS2_PLACEMENT_3D('#9',#6,#8,#7);
#10=CARTESIAN_POINT('#10',(0.0,0.0,0.0));
#11=VERTEX_POINT('#11',#10);
#12=CARTESIAN_POINT('#12',(0.0,50,0.0));
#13=VERTEX_POINT('#13',#12);
#14=CARTESIAN_POINT('#14',(0.0,0.0,50));
#15=VERTEX_POINT('#15',#14);
#16=CARTESIAN_POINT('#16',(0.0,50,50));
#17=VERTEX_POINT('#17',#16);
#18=CARTESIAN_POINT('#18',(50,50,50));
#19=VERTEX_POINT('#19',#18);
```

```
#20=CARTESIAN_POINT(' #20', (50,50,0.0));
#21=VERTEX_POINT(' #21', #20);
#22=CARTESIAN_POINT(' #22', (50,0.0,50));
#23=VERTEX_POINT(' #23', #22);
#24=CARTESIAN_POINT(' #24', (50,0.0,0.0));
#25=VERTEX_POINT(' #25', #24);
#26=CARTESIAN_POINT(' #26', (0.0,0.0,0.0));
#27=DIRECTION(' #27', (0.0,1.0,0.0));
#28=VECTOR(' #28', #27,50);
#29=LINE(' #29', #26, #28);
#30=CARTESIAN_POINT(' #30', (0.0,0.0,0.0));
#31=DIRECTION(' #31', (0.0,0.0,1.0));
#32=VECTOR(' #32', #31,50);
#33=LINE(' #33', #30, #32);
#34=CARTESIAN_POINT(' #34', (0.0,50,50));
#35=DIRECTION(' #35', (0.0,-1,0.0));
#36=VECTOR(' #36', #35,50);
#37=LINE(' #37', #34, #36);
#38=CARTESIAN_POINT(' #38', (0.0,50,50));
#39=DIRECTION(' #39', (0.0,0.0,-1));
#40=VECTOR(' #40', #39,50);
#41=LINE(' #41', #38, #40);
#42=CARTESIAN_POINT(' #42', (0.0,50,50));
#43=DIRECTION(' #43', (1.0,0.0,0.0));
#44=VECTOR(' #44', #43,50);
#45=LINE(' #45', #42, #44);
#46=CARTESIAN_POINT(' #46', (50,50,0.0));
#47=DIRECTION(' #47', (0.0,0.0,1.0));
#48=VECTOR(' #48', #47,50);
#49=LINE(' #49', #46, #48);
#50=CARTESIAN_POINT(' #50', (50,50,0.0));
#51=DIRECTION(' #51', (-1,0.0,0.0));
#52=VECTOR(' #52', #51,50);
#53=LINE(' #53', #50, #52);
#54=CARTESIAN_POINT(' #54', (50,0.0,50));
#55=DIRECTION(' #55', (-1,0.0,0.0));
#56=VECTOR(' #56', #55,50);
#57=LINE(' #57', #54, #56);
#58=CARTESIAN_POINT(' #58', (50,0.0,50));
#59=DIRECTION(' #59', (0.0,1.0,0.0));
#60=VECTOR(' #60', #59,50);
#61=LINE(' #61', #58, #60);
#62=CARTESIAN_POINT(' #62', (0.0,0.0,0.0));
#63=DIRECTION(' #63', (1.0,0.0,0.0));
#64=VECTOR(' #64', #63,50);
#65=LINE(' #65', #62, #64);
#66=CARTESIAN_POINT(' #66', (50,50,0.0));
#67=DIRECTION(' #67', (0.0,-1,0.0));
#68=VECTOR(' #68', #67,50);
#69=LINE(' #69', #66, #68);
#70=CARTESIAN_POINT(' #70', (50,0.0,50));
#71=DIRECTION(' #71', (0.0,0.0,-1));
#72=VECTOR(' #72', #71,50);
#73=LINE(' #73', #70, #72);
#74=EDGE_CURVE(' #74', #11, #13, #29, .T.);
#75=EDGE_CURVE(' #75', #11, #15, #33, .T.);
#76=EDGE_CURVE(' #76', #17, #15, #37, .T.);
#77=EDGE_CURVE(' #77', #17, #13, #41, .T.);
#78=EDGE_CURVE(' #78', #17, #19, #45, .T.);
#79=EDGE_CURVE(' #79', #21, #19, #49, .T.);
#80=EDGE_CURVE(' #80', #21, #13, #53, .T.);
```

```
#81=EDGE_CURVE(' #81', #23, #15, #57, .T.);
#82=EDGE_CURVE(' #82', #23, #19, #61, .T.);
#83=EDGE_CURVE(' #83', #11, #25, #65, .T.);
#84=EDGE_CURVE(' #84', #21, #25, #69, .T.);
#85=EDGE_CURVE(' #85', #23, #25, #73, .T.);
#86=ORIENTED_EDGE(' #86', *, *, #74, .F.);
#87=ORIENTED_EDGE(' #87', *, *, #75, .T.);
#88=ORIENTED_EDGE(' #88', *, *, #76, .F.);
#89=ORIENTED_EDGE(' #89', *, *, #77, .T.);
#90=EDGE_LOOP(' #90', (#86, #87, #88, #89));
#91=FACE_OUTER_BOUND(' #91', #90, .T.);
#92=CARTESIAN_POINT(' #92', (0.0, 25, 25));
#93=DIRECTION(' #93', (-1.0, 0.0, 0.0));
#94=DIRECTION(' #94', (0.0, -1.0, 0.0));
#95=AXIS2_PLACEMENT_3D(' #95', #92, #93, #94);
#96=PLANE(' #96', #95);
#97=ADVANCED_FACE(' #97', (#91), #96, .T.);
#98=ORIENTED_EDGE(' #98', *, *, #77, .F.);
#99=ORIENTED_EDGE(' #99', *, *, #78, .T.);
#100=ORIENTED_EDGE(' #100', *, *, #79, .F.);
#101=ORIENTED_EDGE(' #101', *, *, #80, .T.);
#102=EDGE_LOOP(' #102', (#98, #99, #100, #101));
#103=FACE_OUTER_BOUND(' #103', #102, .T.);
#104=CARTESIAN_POINT(' #104', (25, 50, 25));
#105=DIRECTION(' #105', (0.0, 1.0, 0.0));
#106=DIRECTION(' #106', (0.0, 0.0, 1.0));
#107=AXIS2_PLACEMENT_3D(' #107', #104, #105, #106);
#108=PLANE(' #108', #107);
#109=ADVANCED_FACE(' #109', (#103), #108, .T.);
#110=ORIENTED_EDGE(' #110', *, *, #78, .F.);
#111=ORIENTED_EDGE(' #111', *, *, #76, .T.);
#112=ORIENTED_EDGE(' #112', *, *, #81, .F.);
#113=ORIENTED_EDGE(' #113', *, *, #82, .T.);
#114=EDGE_LOOP(' #114', (#110, #111, #112, #113));
#115=FACE_OUTER_BOUND(' #115', #114, .T.);
#116=CARTESIAN_POINT(' #116', (25, 25, 50));
#117=DIRECTION(' #117', (0.0, 0.0, 1.0));
#118=DIRECTION(' #118', (-1.0, 0.0, 0.0));
#119=AXIS2_PLACEMENT_3D(' #119', #116, #117, #118);
#120=PLANE(' #120', #119);
#121=ADVANCED_FACE(' #121', (#115), #120, .T.);
#122=ORIENTED_EDGE(' #122', *, *, #83, .F.);
#123=ORIENTED_EDGE(' #123', *, *, #74, .T.);
#124=ORIENTED_EDGE(' #124', *, *, #80, .F.);
#125=ORIENTED_EDGE(' #125', *, *, #84, .T.);
#126=EDGE_LOOP(' #126', (#122, #123, #124, #125));
#127=FACE_OUTER_BOUND(' #127', #126, .T.);
#128=CARTESIAN_POINT(' #128', (25, 25, 0.0));
#129=DIRECTION(' #129', (0.0, 0.0, -1.0));
#130=DIRECTION(' #130', (-1.0, 0.0, 0.0));
#131=AXIS2_PLACEMENT_3D(' #131', #128, #129, #130);
#132=PLANE(' #132', #131);
#133=ADVANCED_FACE(' #133', (#127), #132, .T.);
#134=ORIENTED_EDGE(' #134', *, *, #84, .F.);
#135=ORIENTED_EDGE(' #135', *, *, #79, .T.);
#136=ORIENTED_EDGE(' #136', *, *, #82, .F.);
#137=ORIENTED_EDGE(' #137', *, *, #85, .T.);
#138=EDGE_LOOP(' #138', (#134, #135, #136, #137));
#139=FACE_OUTER_BOUND(' #139', #138, .T.);
#140=CARTESIAN_POINT(' #140', (50, 25, 25));
#141=DIRECTION(' #141', (1.0, 0.0, 0.0));
```

```

#142=DIRECTION(' #142', (0.0,1.0,0.0));
#143=AXIS2_PLACEMENT_3D(' #143', #140, #141, #142);
#144=PLANE(' #144', #143);
#145=ADVANCED_FACE(' #145', (#139), #144, .T.);
#146=ORIENTED_EDGE(' #146', *, *, #75, .F.);
#147=ORIENTED_EDGE(' #147', *, *, #83, .T.);
#148=ORIENTED_EDGE(' #148', *, *, #85, .F.);
#149=ORIENTED_EDGE(' #149', *, *, #81, .T.);
#150=EDGE_LOOP(' #150', (#146, #147, #148, #149));
#151=FACE_OUTER_BOUND(' #151', #150, .T.);
#152=CARTESIAN_POINT(' #152', (25,0.0,25));
#153=DIRECTION(' #153', (0.0,-1.0,0.0));
#154=DIRECTION(' #154', (0.0,0.0,-1.0));
#155=AXIS2_PLACEMENT_3D(' #155', #152, #153, #154);
#156=PLANE(' #156', #155);
#157=ADVANCED_FACE(' #157', (#151), #156, .T.);
#158=CLOSED_SHELL(' #158', (#97, #109, #121, #133, #145, #157));
#159=MANIFOLD_SOLID_BREP(' #159', #158);

/* Instances #160-#165 define the text that will be the basis */
/* of an annotation_text_occurrence. */

#160=DRAUGHTING_PRE_DEFINED_TEXT_FONT('ISO 3098-1 font A');
#161=DIRECTION(' #161', (0.0,-1.0,0.0));
#162=DIRECTION(' #162', (1.0,0.0,0.0));
#163=CARTESIAN_POINT(' #163', (30.48304684,74.72529668,-0.02658932493));
#164=AXIS2_PLACEMENT_3D(' #164', #163, #161, #162);
#165=TEXT_LITERAL_WITH_EXTENT(' #165', 'Look at this edge!', #164, 'baseline
right', .RIGHT., #160, #6000);

/* Instances #166-#168 define a generic shape_representation that */
/* has as items the manifold_solid_brep/#159, */
/* the text_literal_with_extent/#165, and */
/* the leader_directed_callout/#200. */
/* This shape_representation is the representation that captures */
/* elements that will be mapped onto the draughting_model/#177. */

#166=UNCERTAINTY_MEASURE_WITH_UNIT(LENGTH_MEASURE(9.999999999999998E-
14), #4, 'distance_accuracy_value', 'EDGE CURVE AND VERTEX POINT ACCURACY');
#167=(GEOMETRIC_REPRESENTATION_CONTEXT(3)
GLOBAL_UNCERTAINTY_ASSIGNED_CONTEXT((#166))
GLOBAL_UNIT_ASSIGNED_CONTEXT((#4, #5, #3))
REPRESENTATION_CONTEXT('MASTER', '3D'));
#168=SHAPE_REPRESENTATION(' #168', (#159, #165, #178, #200), #167);

/* Instances #169-#173 define the annotation_text_occurrence that */
/* represents the text annotation depicted in the figure above. It */
/* references the text_literal_with_extent/#165, which defines the */
/* text string to be represented by the annotation_text_occurrence. */

#169=DRAUGHTING_PRE_DEFINED_COLOUR('black');
#170=TEXT_STYLE_FOR_DEFINED_FONT(#169);
#171=TEXT_STYLE_WITH_BOX_CHARACTERISTICS('a text style', #170,
(BOX_HEIGHT(1.), BOX_WIDTH(1.), BOX_SLANT_ANGLE(0.), BOX_ROTATE_ANGLE(0.));
#172=PRESENTATION_STYLE_ASSIGNMENT((#171));
#173=(ANNOTATION_OCCURRENCE()
ANNOTATION_TEXT_OCCURRENCE()
DRAUGHTING_ANNOTATION_OCCURRENCE()
GEOMETRIC_REPRESENTATION_ITEM()
REPRESENTATION_ITEM('')
STYLED_ITEM((#172), #165));

```

```

/* Instances #174-#177 define the draughting_model, that has as its items*/
/* an axis2_placement_3d/#9 that acts as its origin, */
/* a mapped_item/#175 that maps the previously defined */
/* shape_representation into the draughting_model, */
/* a leader_terminator/#400 which terminates the leader_curve, */
/* the leader_curve/#205, and */
/* the annotation_text_occurrence/#173 defined above. */

```

```

#174=REPRESENTATION_MAP(#178,#168);
#175=MAPPED_ITEM('#175',#174,#9);
#176=(GEOMETRIC_REPRESENTATION_CONTEXT(3)
GLOBAL_UNIT_ASSIGNED_CONTEXT((#4,#5,#3))
REPRESENTATION_CONTEXT('3D Annotation Text Context','3D'));
#177=DRAUGHTING_MODEL('Collect items for presentation',
(#9,#175,#400,#205,#173),#176);
#178=AXIS2_PLACEMENT_3D('#178',#6,#8,#7);

```

```

/* Instances #189-#198 define the product that the cube depicted */
/* above represents, as well as the contexts for the application, */
/* the product, and its definition. Lastly it provides the link */
/* to the generic shape_representation/#168. */

```

```

#189=APPLICATION_CONTEXT('3D shape representation with annotation');
#190=APPLICATION_PROTOCOL_DEFINITION('draft international
standard','automotive_design',1999,#189);
#191=PRODUCT_CONTEXT('',#189,'mechanical');
#192=PRODUCT_DEFINITION_CONTEXT('',#189,'design');
#193=PRODUCT('product_0','','',(#191));
#194=PRODUCT_RELATED_PRODUCT_CATEGORY('part','','',(#193));
#195=PRODUCT_DEFINITION_FORMATION_WITH_SPECIFIED_SOURCE('1','','',#193,.MADE.)
;
#196=PRODUCT_DEFINITION('','',#195,#192);
#197=PRODUCT_DEFINITION_SHAPE('','',#196);
#198=SHAPE_DEFINITION_REPRESENTATION(#197,#168);

```

```

/* Instance #200 defines the leader directed callout that combines*/
/* the leader_curve/#205, */
/* the annotation_text_occurrence/#173, and */
/* the leader_terminator/#400. */

```

```

#200=LEADER_DIRECTED_CALLOUT('callout',(#205,#173,#400));

```

```

/* Instances #205, #250-#254, #270, #300-#304 define the */
/* leader_curve depicted in the figure above. */

```

```

#205=(ANNOTATION_CURVE_OCCURRENCE()
ANNOTATION_OCCURRENCE()
DRAUGHTING_ANNOTATION_OCCURRENCE()
LEADER_CURVE()
REPRESENTATION_ITEM('')
GEOMETRIC_REPRESENTATION_ITEM()
STYLED_ITEM((#300),#250));
#250=TRIMMED_CURVE('',#251,
(PARAMETER_VALUE(0.0),#270),(PARAMETER_VALUE(40.0),#270),
.T.,.PARAMETER.);
#251=LINE('',#253,#255);
#253=CARTESIAN_POINT('',(0,50,0));
#254=DIRECTION('',(0,1,0));
#255=VECTOR('',#254,1.0);

```

```

#270=CARTESIAN_POINT('',(0,0,0));
#300=PRESENTATION_STYLE_ASSIGNMENT(#301);
#301=CURVE_STYLE('',#302,#304,#303);
#302=DRAUGHTING_PRE_DEFINED_CURVE_FONT('continuous');
#303=DRAUGHTING_PRE_DEFINED_COLOUR('black');
#304=LENGTH_MEASURE_WITH_UNIT(POSITIVE_LENGTH_MEASURE(0.1),#4);

/* Instances #400, #410-413, #500, #510-#516 define the terminator for */
/* the leader_curve/#205. */

#400=(ANNOTATION_OCCURRENCE()
ANNOTATION_SYMBOL_OCCURRENCE()
DRAUGHTING_ANNOTATION_OCCURRENCE()
GEOMETRIC_REPRESENTATION_ITEM()
LEADER_TERMINATOR()
REPRESENTATION_ITEM('')
STYLED_ITEM(#410,#500)
TERMINATOR_SYMBOL(#205));
#410=PRESENTATION_STYLE_ASSIGNMENT(#411);
#411=SYMBOL_STYLE('red colour',#412);
#412=SYMBOL_COLOUR(#413);
#413=DRAUGHTING_PRE_DEFINED_COLOUR('black');
#500=DEFINED_SYMBOL('',#510,#514);
#510=PRE_DEFINED_TERMINATOR_SYMBOL('open arrow');
#511=AXIS2_PLACEMENT_3D('',#512,#513,#516);
#512=CARTESIAN_POINT('',(0.0,50.0,0.0));
#513=DIRECTION('',(1.0,0.0,0.0));
#514=SYMBOL_TARGET('',#511,7.5,2.5);
#516=DIRECTION('',(0.0,1.0,0.0));

/* Instances #3000, #3010, #3015, and #3020 define the shape_aspect */
/* that captures the geometric model element (i.e., an edge_curve/#74) */
/* that will be associated with annotation text. */

#3000=SHAPE_ASPECT('', 'aspect to capture model element
for association',#197,.T.);
#3010=PROPERTY_DEFINITION('', '#3000);
#3015=SHAPE_DEFINITION_REPRESENTATION(#3010,#3020);
#3020=SHAPE_REPRESENTATION('',(#74), #167);

/* Instances #4000, #4010, #4015, and #4020 define the shape_aspect that */
/* captures the leader_curve/#205 that will be associated with the */
/* edge_curve of the geometric model. */

#4000=SHAPE_ASPECT('', 'shape aspect for leader curve',#197,.F.);
#4010=PROPERTY_DEFINITION('', '#4000);
#4020=SHAPE_DEFINITION_REPRESENTATION(#4010,#4030);
#4030=SHAPE_REPRESENTATION('',(#200),#167);

/* Instance #5000 explicitly defines the association between */
/* the two previously defined shape_aspect entity data types; */
/* one representing the model element and the other the */
/* leader_curve. */

#5000=SHAPE_ASPECT_ASSOCIATIVITY('', 'associativity between model element
and
leader curve',#3000,#4000);

/* Instance #6000 defines the planar_extent used to define the */
/* occupying space for the text string defined in #165. */

```

```
#6000=PLANAR_EXTENT('extent of text string',60,10);
ENDSEC;
END-ISO-10303-21;
```

## 4.2 Conforming to AP203 with a modular extension

```
ISO-10303-21;
HEADER;
FILE_DESCRIPTION(('associative text example',''),'2;1');
FILE_NAME('assoctext203.stp',
          '1998-11-02 T01:23:51',
          (''),
          ('',' ',' ')),
          ('',
          ' ',
          ' ');
FILE_SCHEMA(('associative_text203'));
ENDSEC;
DATA;

/* Instances #1-#159 define the cube depicted above. */

#1=DIMENSIONAL_EXPONENTS(1.0,0.0,0.0,0.0,0.0,0.0,0.0);
#2=DIMENSIONAL_EXPONENTS(0.0,0.0,0.0,0.0,0.0,0.0,0.0);
#3=(NAMED_UNIT(*)SI_UNIT($,.STERADIAN.)SOLID_ANGLE_UNIT());
#4=(LENGTH_UNIT()NAMED_UNIT(*)SI_UNIT(.MILLI.,.METRE.));
#5=(NAMED_UNIT(*)PLANE_ANGLE_UNIT()SI_UNIT($,.RADIAN.));
#6=CARTESIAN_POINT('#6',(0.0,0.0,0.0));
#7=DIRECTION('#7',(1.0,0.0,0.0));
#8=DIRECTION('#8',(0.0,0.0,1.0));
#9=AXIS2_PLACEMENT_3D('#9',#6,#8,#7);
#10=CARTESIAN_POINT('#10',(0.0,0.0,0.0));
#11=VERTEX_POINT('#11',#10);
#12=CARTESIAN_POINT('#12',(0.0,50.,0.0));
#13=VERTEX_POINT('#13',#12);
#14=CARTESIAN_POINT('#14',(0.0,0.0,50.));
#15=VERTEX_POINT('#15',#14);
#16=CARTESIAN_POINT('#16',(0.0,50.,50.));
#17=VERTEX_POINT('#17',#16);
#18=CARTESIAN_POINT('#18',(50.,50.,50.));
#19=VERTEX_POINT('#19',#18);
#20=CARTESIAN_POINT('#20',(50.,50.,0.0));
#21=VERTEX_POINT('#21',#20);
#22=CARTESIAN_POINT('#22',(50.,0.0,50.));
#23=VERTEX_POINT('#23',#22);
#24=CARTESIAN_POINT('#24',(50.,0.0,0.0));
#25=VERTEX_POINT('#25',#24);
#26=CARTESIAN_POINT('#26',(0.0,0.0,0.0));
#27=DIRECTION('#27',(0.0,1.0,0.0));
#28=VECTOR('#28',#27,50.);
#29=LINE('#29',#26,#28);
#30=CARTESIAN_POINT('#30',(0.0,0.0,0.0));
#31=DIRECTION('#31',(0.0,0.0,1.0));
#32=VECTOR('#32',#31,50.);
#33=LINE('#33',#30,#32);
#34=CARTESIAN_POINT('#34',(0.0,50.,50.));
#35=DIRECTION('#35',(0.0,-1.,0.0));
#36=VECTOR('#36',#35,50.);
#37=LINE('#37',#34,#36);
#38=CARTESIAN_POINT('#38',(0.0,50.,50.));
#39=DIRECTION('#39',(0.0,0.0,-1.));
#40=VECTOR('#40',#39,50.);
```



```
#41=LINE(' #41', #38, #40);
#42=CARTESIAN_POINT(' #42', (0.0, 50., 50.));
#43=DIRECTION(' #43', (1.0, 0.0, 0.0));
#44=VECTOR(' #44', #43, 50.);
#45=LINE(' #45', #42, #44);
#46=CARTESIAN_POINT(' #46', (50., 50., 0.0));
#47=DIRECTION(' #47', (0.0, 0.0, 1.0));
#48=VECTOR(' #48', #47, 50.);
#49=LINE(' #49', #46, #48);
#50=CARTESIAN_POINT(' #50', (50., 50., 0.0));
#51=DIRECTION(' #51', (-1., 0.0, 0.0));
#52=VECTOR(' #52', #51, 50.);
#53=LINE(' #53', #50, #52);
#54=CARTESIAN_POINT(' #54', (50., 0.0, 50.));
#55=DIRECTION(' #55', (-1., 0.0, 0.0));
#56=VECTOR(' #56', #55, 50.);
#57=LINE(' #57', #54, #56);
#58=CARTESIAN_POINT(' #58', (50., 0.0, 50.));
#59=DIRECTION(' #59', (0.0, 1.0, 0.0));
#60=VECTOR(' #60', #59, 50.);
#61=LINE(' #61', #58, #60);
#62=CARTESIAN_POINT(' #62', (0.0, 0.0, 0.0));
#63=DIRECTION(' #63', (1.0, 0.0, 0.0));
#64=VECTOR(' #64', #63, 50.);
#65=LINE(' #65', #62, #64);
#66=CARTESIAN_POINT(' #66', (50., 50., 0.0));
#67=DIRECTION(' #67', (0.0, -1., 0.0));
#68=VECTOR(' #68', #67, 50.);
#69=LINE(' #69', #66, #68);
#70=CARTESIAN_POINT(' #70', (50., 0.0, 50.));
#71=DIRECTION(' #71', (0.0, 0.0, -1.));
#72=VECTOR(' #72', #71, 50.);
#73=LINE(' #73', #70, #72);
#74=EDGE_CURVE(' #74', #11, #13, #29, .T.);
#75=EDGE_CURVE(' #75', #11, #15, #33, .T.);
#76=EDGE_CURVE(' #76', #17, #15, #37, .T.);
#77=EDGE_CURVE(' #77', #17, #13, #41, .T.);
#78=EDGE_CURVE(' #78', #17, #19, #45, .T.);
#79=EDGE_CURVE(' #79', #21, #19, #49, .T.);
#80=EDGE_CURVE(' #80', #21, #13, #53, .T.);
#81=EDGE_CURVE(' #81', #23, #15, #57, .T.);
#82=EDGE_CURVE(' #82', #23, #19, #61, .T.);
#83=EDGE_CURVE(' #83', #11, #25, #65, .T.);
#84=EDGE_CURVE(' #84', #21, #25, #69, .T.);
#85=EDGE_CURVE(' #85', #23, #25, #73, .T.);
#86=ORIENTED_EDGE(' #86', *, *, #74, .F.);
#87=ORIENTED_EDGE(' #87', *, *, #75, .T.);
#88=ORIENTED_EDGE(' #88', *, *, #76, .F.);
#89=ORIENTED_EDGE(' #89', *, *, #77, .T.);
#90=EDGE_LOOP(' #90', (#86, #87, #88, #89));
#91=FACE_OUTER_BOUND(' #91', #90, .T.);
#92=CARTESIAN_POINT(' #92', (0.0, 25., 25.));
#93=DIRECTION(' #93', (-1.0, 0.0, 0.0));
#94=DIRECTION(' #94', (0.0, -1.0, 0.0));
#95=AXIS2_PLACEMENT_3D(' #95', #92, #93, #94);
#96=PLANE(' #96', #95);
#97=ADVANCED_FACE(' #97', (#91), #96, .T.);
#98=ORIENTED_EDGE(' #98', *, *, #77, .F.);
#99=ORIENTED_EDGE(' #99', *, *, #78, .T.);
#100=ORIENTED_EDGE(' #100', *, *, #79, .F.);
#101=ORIENTED_EDGE(' #101', *, *, #80, .T.);
```

```

#102=EDGE_LOOP(' #102', (#98,#99,#100,#101));
#103=FACE_OUTER_BOUND(' #103', #102, .T.);
#104=CARTESIAN_POINT(' #104', (25.,50.,25.));
#105=DIRECTION(' #105', (0.0,1.0,0.0));
#106=DIRECTION(' #106', (0.0,0.0,1.0));
#107=AXIS2_PLACEMENT_3D(' #107', #104,#105,#106);
#108=PLANE(' #108', #107);
#109=ADVANCED_FACE(' #109', (#103),#108, .T.);
#110=ORIENTED_EDGE(' #110', *,*,#78, .F.);
#111=ORIENTED_EDGE(' #111', *,*,#76, .T.);
#112=ORIENTED_EDGE(' #112', *,*,#81, .F.);
#113=ORIENTED_EDGE(' #113', *,*,#82, .T.);
#114=EDGE_LOOP(' #114', (#110,#111,#112,#113));
#115=FACE_OUTER_BOUND(' #115', #114, .T.);
#116=CARTESIAN_POINT(' #116', (25.,25.,50.));
#117=DIRECTION(' #117', (0.0,0.0,1.0));
#118=DIRECTION(' #118', (-1.0,0.0,0.0));
#119=AXIS2_PLACEMENT_3D(' #119', #116,#117,#118);
#120=PLANE(' #120', #119);
#121=ADVANCED_FACE(' #121', (#115),#120, .T.);
#122=ORIENTED_EDGE(' #122', *,*,#83, .F.);
#123=ORIENTED_EDGE(' #123', *,*,#74, .T.);
#124=ORIENTED_EDGE(' #124', *,*,#80, .F.);
#125=ORIENTED_EDGE(' #125', *,*,#84, .T.);
#126=EDGE_LOOP(' #126', (#122,#123,#124,#125));
#127=FACE_OUTER_BOUND(' #127', #126, .T.);
#128=CARTESIAN_POINT(' #128', (25.,25.,0.0));
#129=DIRECTION(' #129', (0.0,0.0,-1.0));
#130=DIRECTION(' #130', (-1.0,0.0,0.0));
#131=AXIS2_PLACEMENT_3D(' #131', #128,#129,#130);
#132=PLANE(' #132', #131);
#133=ADVANCED_FACE(' #133', (#127),#132, .T.);
#134=ORIENTED_EDGE(' #134', *,*,#84, .F.);
#135=ORIENTED_EDGE(' #135', *,*,#79, .T.);
#136=ORIENTED_EDGE(' #136', *,*,#82, .F.);
#137=ORIENTED_EDGE(' #137', *,*,#85, .T.);
#138=EDGE_LOOP(' #138', (#134,#135,#136,#137));
#139=FACE_OUTER_BOUND(' #139', #138, .T.);
#140=CARTESIAN_POINT(' #140', (50.,25.,25.));
#141=DIRECTION(' #141', (1.0,0.0,0.0));
#142=DIRECTION(' #142', (0.0,1.0,0.0));
#143=AXIS2_PLACEMENT_3D(' #143', #140,#141,#142);
#144=PLANE(' #144', #143);
#145=ADVANCED_FACE(' #145', (#139),#144, .T.);
#146=ORIENTED_EDGE(' #146', *,*,#75, .F.);
#147=ORIENTED_EDGE(' #147', *,*,#83, .T.);
#148=ORIENTED_EDGE(' #148', *,*,#85, .F.);
#149=ORIENTED_EDGE(' #149', *,*,#81, .T.);
#150=EDGE_LOOP(' #150', (#146,#147,#148,#149));
#151=FACE_OUTER_BOUND(' #151', #150, .T.);
#152=CARTESIAN_POINT(' #152', (25.,0.0,25.));
#153=DIRECTION(' #153', (0.0,-1.0,0.0));
#154=DIRECTION(' #154', (0.0,0.0,-1.0));
#155=AXIS2_PLACEMENT_3D(' #155', #152,#153,#154);
#156=PLANE(' #156', #155);
#157=ADVANCED_FACE(' #157', (#151),#156, .T.);
#158=CLOSED_SHELL(' #158', (#97,#109,#121,#133,#145,#157));
#159=MANIFOLD_SOLID_BREP(' #159', #158);

```

```

/* Instances #160-#165 define the text that will be the basis */
/* of an annotation_text_occurrence. */

```

```

#160=DRAUGHTING_PRE_DEFINED_TEXT_FONT('ISO 3098-1 font A');

#163=CARTESIAN_POINT('#163',(30.48304684,74.72529668,-0.02658932493));
#164=AXIS2_PLACEMENT_3D('#164',#163,$,$);
#165=TEXT_LITERAL_WITH_EXTENT('#165','Look at this edge!','#164,'baseline
right',.RIGHT.,#160,#6000);

/* Instances #166-#168 define a generic shape_representation that */
/* has as items the manifold_solid_brep/#159, */
/* the text_literal_with_extent/#165, and */
/* the leader_directed_callout/#200. */
/* This shape_representation is the representation that captures */
/* elements that will be mapped onto the draughting_model/#177. */

#166=UNCERTAINTY_MEASURE_WITH_UNIT(LENGTH_MEASURE(9.999999999999998E-
14),#4,'distance_accuracy_value','EDGE CURVE AND VERTEX POINT ACCURACY');
#167=(GEOMETRIC_REPRESENTATION_CONTEXT(3)
GLOBAL_UNCERTAINTY_ASSIGNED_CONTEXT((#166))
GLOBAL_UNIT_ASSIGNED_CONTEXT((#4,#5,#3))
REPRESENTATION_CONTEXT('MASTER','3D'));
#168=SHAPE_REPRESENTATION('#168',(#159,#165,#178,#200),#167);

/* Instances #169-#173 define the annotation_text_occurrence that */
/* represents the text annotation depicted in the figure above. It */
/* references the text_literal_with_extent/#165, which defines the */
/* text string to be represented by the annotation_text_occurrence. */

#169=DRAUGHTING_PRE_DEFINED_COLOUR('black');
#170=TEXT_STYLE_FOR_DEFINED_FONT(#169);
#171=TEXT_STYLE_WITH_BOX_CHARACTERISTICS('a text style',#170,
(BOX_HEIGHT(1.),BOX_WIDTH(1.),BOX_SLANT_ANGLE(0.),BOX_ROTATE_ANGLE(0.));
#172=PRESENTATION_STYLE_ASSIGNMENT((#171));
#173=(ANNOTATION_OCCURRENCE()
ANNOTATION_TEXT_OCCURRENCE()
DRAUGHTING_ANNOTATION_OCCURRENCE()
GEOMETRIC_REPRESENTATION_ITEM()
REPRESENTATION_ITEM('')
STYLED_ITEM((#172),#165));

/* Instances #174-#177 define the draughting_model, that has as its items*/
/* an axis2_placement_3d/#9 that acts as its origin, */
/* a mapped_item/#175 that maps the previously defined */
/* shape_representation into the draughting_model, */
/* a leader_terminator/#400 which terminates the leader_curve, */
/* the leader_curve/#205, and */
/* the annotation_text_occurrence/#173 defined above. */

#174=REPRESENTATION_MAP(#178,#168);
#175=MAPPED_ITEM('#175',#174,#9);
#176=(GEOMETRIC_REPRESENTATION_CONTEXT(3)
GLOBAL_UNIT_ASSIGNED_CONTEXT((#4,#5,#3))
REPRESENTATION_CONTEXT('3D Annotation Text Context','3D'));
#177=DRAUGHTING_MODEL('Collect items for presentation',
(#9,#175,#400,#205,#173),#176);
#178=AXIS2_PLACEMENT_3D('#178',#6,#8,#7);

/* Instances #189-#198 define the product that the cube depicted */
/* above represents, as well as the contexts for the application, */
/* the product, and its definition. Lastly it provides the link */

```

```

/* to the generic shape_representation/#168. */

#189=APPLICATION_CONTEXT('3D associative text');
#190=APPLICATION_PROTOCOL_DEFINITION('working draft
','3D_associative_text',1998,#189);
#191=MECHANICAL_CONTEXT(' ',#189,'mechanical');
#192=DESIGN_CONTEXT(' ',#189,'design');
#193=PRODUCT('product_0','','',(#191));
#194=PRODUCT_RELATED_PRODUCT_CATEGORY('detail','',(#193));
#195=PRODUCT_DEFINITION_FORMATION_WITH_SPECIFIED_SOURCE('1','',#193,.MADE.)
;
#196=PRODUCT_DEFINITION('','',#195,#192);
#197=PRODUCT_DEFINITION_SHAPE('','',#196);
#198=SHAPE_DEFINITION_REPRESENTATION(#197,#168);

/* Instance #200 defines the leader directed callout that combines */
/* the leader_curve/#205, */
/* the annotation_text_occurrence/#173, and */
/* the leader_terminator/#400. */

#200=LEADER_DIRECTED_CALLOUT('callout',(#205,#173,#400));

/* Instances #205, #250-#254, #270, #300-#304 define the */
/* leader_curve depicted in the figure above. */

#205=(ANNOTATION_CURVE_OCCURRENCE()
ANNOTATION_OCCURRENCE()
DRAUGHTING_ANNOTATION_OCCURRENCE()
LEADER_CURVE()
REPRESENTATION_ITEM('')
GEOMETRIC_REPRESENTATION_ITEM()
STYLED_ITEM((#300),#250));
#250=TRIMMED_CURVE('',#251,
(PARAMETER_VALUE(0.0)),(PARAMETER_VALUE(1.0)),
.T.,.PARAMETER.);
#251=LINE('',#253,#252);
#252=VECTOR('',#254,1.);
#253=CARTESIAN_POINT('',(0.,50.,0.));
#254=DIRECTION('',(0.,1.,0.));

#300=PRESENTATION_STYLE_ASSIGNMENT((#301));
#301=CURVE_STYLE('',#302,#304,#303);
#302=DRAUGHTING_PRE_DEFINED_CURVE_FONT('continuous');
#303=DRAUGHTING_PRE_DEFINED_COLOUR('black');
#304=LENGTH_MEASURE_WITH_UNIT(POSITIVE_LENGTH_MEASURE(0.1),#4);

/* Instances #400, #410-413, #500, #510-#516 define the terminator for */
/* the leader_curve/#205. */

#400=(ANNOTATION_OCCURRENCE()
ANNOTATION_SYMBOL_OCCURRENCE()
DRAUGHTING_ANNOTATION_OCCURRENCE()
GEOMETRIC_REPRESENTATION_ITEM()
LEADER_TERMINATOR()
REPRESENTATION_ITEM('')
STYLED_ITEM((#410),#500)
TERMINATOR_SYMBOL(#205));
#410=PRESENTATION_STYLE_ASSIGNMENT((#411));
#411=SYMBOL_STYLE('red colour',#412);
#412=SYMBOL_COLOUR(#413);
#413=DRAUGHTING_PRE_DEFINED_COLOUR('black');

```

```

#500=DEFINED_SYMBOL('',#510,#514);
#510=PRE_DEFINED_TERMINATOR_SYMBOL('filled arrow');
#511=AXIS2_PLACEMENT_3D('',#512,#513,#516);
#512=CARTESIAN_POINT('',(0.0,50.0,0.0));
#513=DIRECTION('',(1.0,0.0,0.0));
#514=SYMBOL_TARGET('',#511,7.5,2.5);
#516=DIRECTION('',(0.0,1.0,0.0));

/* Instances #3000, #3010, #3015, and #3020 define the shape_aspect */
/* that captures the geometric model element (i.e., an edge_curve/#74) */
/* that will be associated with annotation text. */

#3000=SHAPE_ASPECT('', 'aspect to capture model element
for association',#197,.T.);
#3010=PROPERTY_DEFINITION('', '#3000);
#3015=SHAPE_DEFINITION_REPRESENTATION(#3010,#3020);
#3020=SHAPE_REPRESENTATION('', (#74), #167);

/* Instances #4000, #4010, #4015, and #4020 define the shape_aspect that */
/* captures the leader_curve/#205 that will be associated with the */
/* edge_curve of the geometric model. */

#4000=SHAPE_ASPECT('', 'shape aspect for leader curve',#197,.F.);
#4010=PROPERTY_DEFINITION('', '#4000);
#4020=SHAPE_DEFINITION_REPRESENTATION(#4010,#4030);
#4030=SHAPE_REPRESENTATION('', (#200),#167);

/* Instance #5000 explicitly defines the association between */
/* the two previously defined shape_aspect entity data types; */
/* one representing the model element and the other the */
/* leader_curve. */

#5000=SHAPE_ASPECT_ASSOCIATIVITY('', 'associativity between model element
and
leader curve',#3000,#4000);

/* Instance #6000 defines the planar_extent used to define the */
/* occupying space for the text string defined in #165. */

#6000=PLANAR_EXTENT('extent of text string',60.,10.);

/* Instances #7001-#7031 define administrative product */
/* identification information required by AP203. */

#7001=SECURITY_CLASSIFICATION_LEVEL('unclassified');
#7002=SECURITY_CLASSIFICATION('', '#7001);
#7003=CC_DESIGN_SECURITY_CLASSIFICATION(#7002, (#195));
#7004=APPROVAL_STATUS('approved');
#7005=APPROVAL(#7004, '');
#7006=CC_DESIGN_APPROVAL(#7005, (#7002, #195, #196));
#7007=CALENDAR_DATE(1998,10,10);
#7008=COORDINATED_UNIVERSAL_TIME_OFFSET(4,0,.BEHIND.);
#7009=LOCAL_TIME(16,15,3.3E1,#7008);
#7010=DATE_AND_TIME(#7007,#7009);
#7011=APPROVAL_DATE_TIME(#7010,#7005);
#7012=DATE_TIME_ROLE('creation_date');
#7013=CC_DESIGN_DATE_AND_TIME_ASSIGNMENT(#7010,#7012, (#196));
#7014=DATE_TIME_ROLE('classification_date');
#7015=CC_DESIGN_DATE_AND_TIME_ASSIGNMENT(#7010,#7014, (#7002));

```

```
#7016=PERSON('UNSPECIFIED','UNSPECIFIED',$,$,$,$);
#7017=ORGANIZATION('UNSPECIFIED','UNSPECIFIED','UNSPECIFIED');
#7018=PERSON_AND_ORGANIZATION(#7016,#7017);
#7019=APPROVAL_ROLE('approver');
#7020=APPROVAL_PERSON_ORGANIZATION(#7018,#7005,#7019);
#7021=PERSON_AND_ORGANIZATION_ROLE('creator');
#7022=CC_DESIGN_PERSON_AND_ORGANIZATION_ASSIGNMENT(#7018,#7021,(#195,#196))
;
#7023=PERSON_AND_ORGANIZATION_ROLE('design_supplier');
#7024=CC_DESIGN_PERSON_AND_ORGANIZATION_ASSIGNMENT(#7018,#7023,(#195));
#7025=PERSON_AND_ORGANIZATION_ROLE('classification_officer');
#7026=CC_DESIGN_PERSON_AND_ORGANIZATION_ASSIGNMENT(#7018,#7025,(#7002));
#7027=PERSON_AND_ORGANIZATION_ROLE('design_owner');
#7028=CC_DESIGN_PERSON_AND_ORGANIZATION_ASSIGNMENT(#7018,#7027,(#193));
#7030=PRODUCT_CATEGORY('part',' ');
#7031=PRODUCT_CATEGORY_RELATIONSHIP(' ',' ',#7030,#194);
ENDSEC;
END-ISO-10303-21;
```

Instance diagrams depicting the use of the concepts described in 3.1, 3.2, 3.4, and 3.5 with the instances defined in the Part 21 file are shown in diagrams 10 and 11 below.

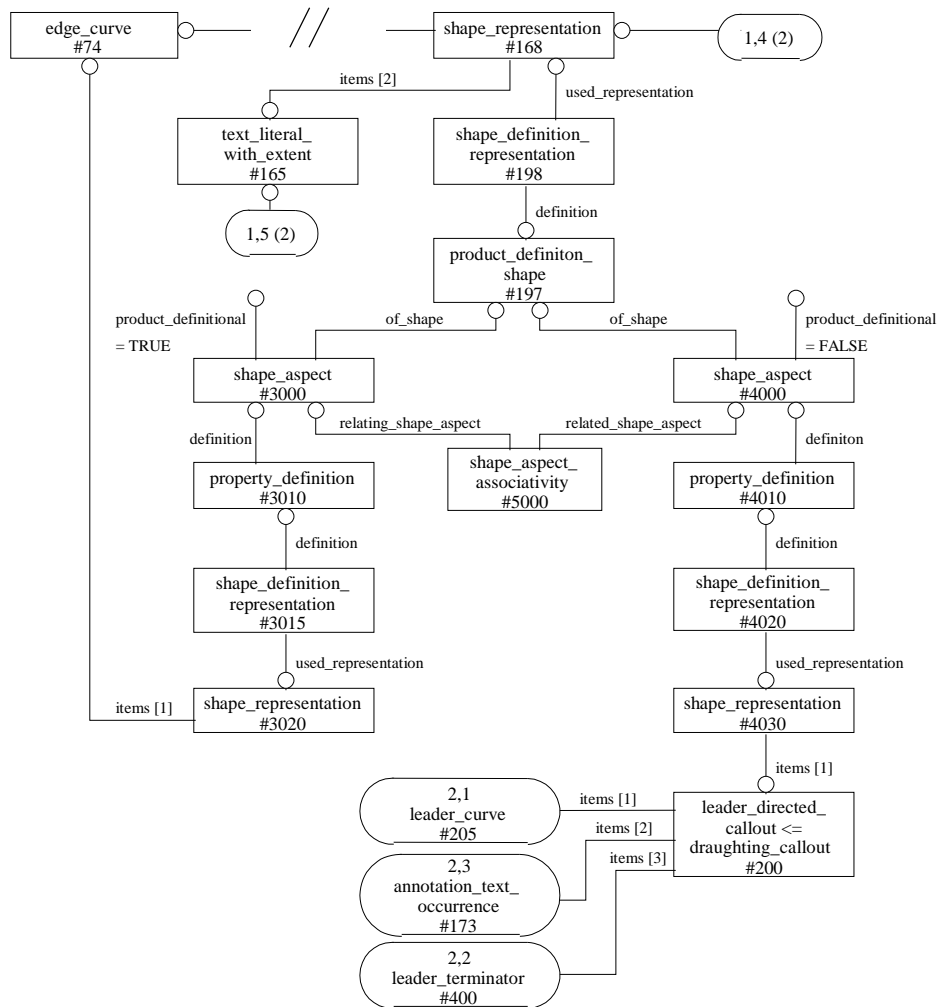

Figure 10 : Instance diagram 1

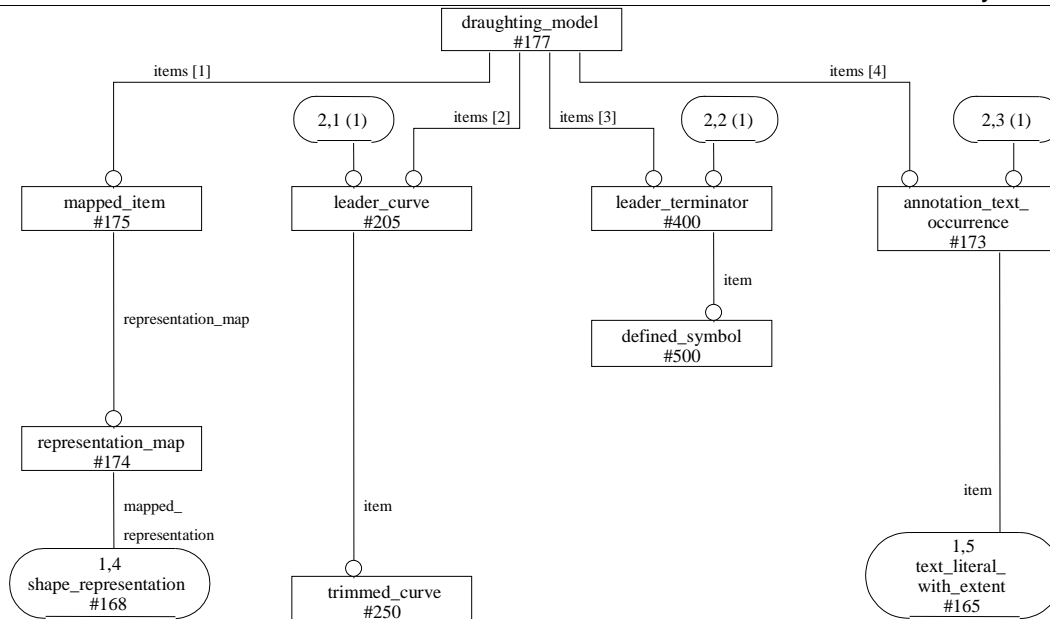

FIGURE 11 : INSTANCE DIAGRAM 2

## 5 Known issues

### 5.1 Restrictiveness of shape\_aspect\_associativity

In our opinion, **shape\_aspect\_associativity** is too constrained within AP202 and AP214. It only allows for associations of leader curves, projection curves, or fill area boundaries to geometric model elements. It should allow for other types of annotation associations as well. What if someone wanted to associate an `annotation_text_occurrence` that is NOT directed to a shape element via a leader curve or a projection curve? There are systems that automatically compute the leader curves given the association between annotation and elements. The instantiation of the leader curves in these CAD kernels are not transparent to the API used for the STEP processors. Thus for these systems the exchange of associated text without leader curves is an important case.

### 5.2 AP 214 global rules

The approach requires the removal of the global rule `draughting_model_annotation_layers` FOR (`draughting_model`). This rule states that each `annotation_occurrence` shall have a `presentation_layer` assigned. Since there are systems that support associative text as 3D notes but do not have layers, this rule is seen as too restrictive in the scope of this effort.

### 5.3 Associated draughting\_callout application object in AP214 ARM

The capability described herein strongly corresponds to the `associated_draughting_callout` application object described in the AP214 application reference model as a requirement. Unfortunately the mapping specified in 214 does not fully cover the requirements associated with this effort. A ballot comment to AP214 DIS to adapt the approach described herein has been submitted and is being incorporated into the document.

### 5.4 AP 203 global rules

The schema combining `associative_text` and AP 203 requires the removal of following rules:

- RULE `application_context_requires_ap_definition` FOR (`application_context`, `application_protocol_definition`);

- RULE subtype\_mandatory\_representation FOR (representation);
- RULE subtype\_mandatory\_shape\_representation FOR (shape\_representation);

## 6 Availability of implementation schemas

### 6.1 AP214

The AP214 DIS schema supports the implementation of the capabilities as described. The schema can be retrieved via anonymous ftp from:

[ftp://ftp.prostep.de/pub/AP214/Schemas/DIS/automotive\\_design.exp](ftp://ftp.prostep.de/pub/AP214/Schemas/DIS/automotive_design.exp)

### 6.2 AP203 with modular extensions

The short form for the associative dimensions extension, its corresponding long form, and the long form schema combining AP 203 and the associative dimension can be accessed via the WWW from:

<http://www.cax-if.org>

## 7 Summary of changes to Document

In this section, a summary of the change(s) made to the recommended practice document is recorded.

### 7.1 Current Release

In this release of the recommended practice, the following changes are made with respect to the previous version of the document dated 10-07-99 and which is available from the CAx IF websites -- <http://www.cax-if.org> and <http://www.cax-if.de> .

#### 7.1.1 Contacts

Linas Polikaitas is no longer a contact for this recommended practices document.

#### 7.1.2 Section 3.4 Associativity between separate elements of annotation

There is a constraint added that the related\_annotation\_occurrence can be either a leader\_curve, projection-curve, or a annotation\_fill\_area\_occurrence entity. Also, the entity numbers have been deleted, since they have been deleted from the Part 21 file example. The issue regarding restrictiveness of annotation\_occurrence\_associativity has also been deleted (see 7.1.6).

#### 7.1.3 Section 3.8.3 Usage of annotation\_occurrence\_associativity deleted.

This section has been deleted. The rationale for the deletion is as follows:

It is assumed that a leader\_directed\_callout will only contain one leader curve. Therefore, the annotation\_occurrence\_associativity instance is no longer needed. An instance of this entity is only used to support associativity between a draughting callout and an annotation element.

#### 7.1.4 #2000 in Part 21 file example deleted

In line with the discussion presented in Section 7.1.2 and 7.1.3 of this document, #2000 in the example Part 21 files (AP214 and AP203 and extensions), which is a annotation\_occurrence\_associativity element, has been deleted.



### 7.1.5 Modification in Figure 11: Instance Diagram 2

To reflect the change indicated in Section 7.1.4 of this document, namely the deletion of the `annotation_occurrence_associativity` entity, the instance diagram has also been modified.

### 7.1.6 Known Issue: Section 5.2 Restrictiveness of `annotation_occurrence_associativity` deleted

This issue is not valid anymore. The general associativity between annotation elements is supported by the supertype `annotation_occurrence_relationship`.